

State of Practice For the Design of Socketed Piles in Rock

P.J.N. Pells

BSc (Eng), MSc (Eng), DIC, DSc(Eng)
Partner, Pells Sullivan Meynink Pty. Ltd., Australia

Summary Development over the past three decades in design methods for axial and lateral loads on rock socketed piles are summarised. The key factors which influence design for axial loading are presented and detailed descriptions are given of three appropriate design methods, together with worked examples. The implementation of Limit State design concepts for socketed piles is described. The writer concludes that the method by Rowe and Armitage is currently the most satisfactory design tool, although it is acknowledged that methods based on fundamental parameters controlling side shear have substantial value in assessing socketed pile behaviour.

The state of practice in regard to lateral loading of rock sockets is substantially less satisfactory than for axial loading. Calculation of elastic displacements and rotations can be made using equations developed by Carter and Kulhawy. However, methods for assessing ultimate strength capacity for lateral loading are poorly developed.

1. INTRODUCTION

The design of bored piles socketed into rock has developed from the situation in the late 1960's of "no satisfactory basis for design" (Tomlinson as quoted in Gill, 1970) to the point that good design methods are now available which properly take in to account the applied mechanics of the problem and the properties of rock masses.

The objectives of this article are to provide an overview of developments in the past three decades, to provide a guide to the plethora of publications on the subject and to set out the design methods which the writer considers may now be adopted within the framework of limit state design.

some parts of the UK. Early work in the bearing capacity of rock was done by Ladanyi (Ref 8) and Bishnoi (Ref 2), while Gill (Ref 4) produced the first detailed study of the load distribution in a rock socketed pile using linear and non-linear, finite element analyses.

To a substantial extent workers in Australia at Monash University and Sydney University picked up the baton in the late 1970's and undertook substantial field and laboratory testing and theoretical studies (Refs 9, 10, 16, 17 and 18). In Canada, Horvath (Ref 6) undertook similar field and laboratory testing. Interaction continued with north American workers (eg Kulhawy, Ref 7 and Rowe, Ref 12) and culminated in three key publications, namely:

2. A BRIEF HISTORY OF DEVELOPMENTS

The developments discussed here relate primarily to the parts of the world which use English as the basis of technical communication. This covers North America, Great Britain, Australasia, much of Africa and parts of South America. However, it does not cover most of Europe, the middle East, China and Japan. The writer admits to ignorance in relation to developments and current design methods used in these "non-English" regions.

It appears to have been in Canada, and patches of the USA, in the late 1960's and early 1970's that serious research started which ignited interest in Australia, South Africa, other parts of the USA and

- Structural Foundation on Rock (International Conference held in Sydney in 1980).
- The Design of Piles Socketed into weak Rock (National Research Council, Ottawa, 1984).
- Analysis and Design of Drilled Shaft Foundations Socketed into Rock (Cornell University, 1987).

The writer believes that these three publications contain all that is required for proper design of rock socketed piles. They contain several different design methods but all include the essential features for appropriately including rock mass properties and the applied mechanics of pile/ground interaction. In essence there are three methods incorporated in these publications, namely:

- Elastic design (Pells et al, Ref 9, 10)
- Side Slip design (Rowe & Armitage, Ref 12 and Carter and Kulhawy, Ref 3)
- Non-Linear design (Williams et al, Ref 17, Seidel & Haberfield, Ref 14)

Since the peak period of the 1980's research and field testing work has continued particularly at Monash University (Ref 13 and 14) where a commercial computer program, ROCKET, has been developed which provides a design tool based on analyses incorporating a detailed understanding of the role of sidewall roughness on the performance of socketed piles.

3. IMPORTANT CONSIDERATIONS IN THE DESIGN PROCESS

There are some simple but key matters which, at the outset, must be clearly understood. These fall into three categories namely:

1. Construction methodology and quality control.
2. Knowledge of the rock mass properties.
3. Applied mechanics of socket behaviour.

3.1 Construction Methodology and Quality Control

The over-riding question is whether the socketed pile is to be designed for load sharing between side and base or whether it is to be a side-shear only design. This decision depends entirely on whether the construction method is to be such that:

- the base of the socket will be clean; this is taken to mean less than 10% of the base area covered by loosened material and construction debris, and
- placement of concrete will be by methods which ensure high quality concrete at the base of the pile.

If both of these requirements cannot be achieved, and confirmed by inspection (Ref 5), then the pile should be designed for side-shear only. This has important implications in regard to the design safety factor because without the "back-up" of end bearing total reliance rests on the side shear strength.

The second construction issue relates to sidewall cleanliness and roughness. The design parameters and methods discussed here presume that the socket sidewalls will be free of crushed and smeared rock. They also presume a knowledge of the sidewall roughness. Ensuring clean sidewalls of appropriate roughness is not a trivial construction problem. The writer's experience with Sydney sandstones and shales, and with the sedimentary foundation rocks of Brisbane's Gateway Bridge, suggests that the easiest way to ensure clean sidewalls is for the socket to be drilled under water. Alternatively the socket hole can be filled with water after drilling and then stirred using the drilling bucket or auger. Another alternative is to use a special tool fitted with sidewall cleaning teeth which is passed up and down the socket a few times after completion of drilling. This latter approach has to be used in rocks which soften or slake significantly when exposed to free water.

Before leaving this topic of construction it must be noted that a great number of socketed piles are installed using simple auger drilling equipment and under conditions where there is insufficient attention given to adequate base or sidewall cleanliness. For such foundations the modern design parameters and methods for socketed piles are inappropriate and one can simply hope that those responsible for such work assume very conservative allowable loads.

3.2 Knowledge of Rock Mass Parameters

In essence all the modern design methods require good knowledge of:

1. The equivalent Young's moduli of the rock adjacent to the sidewalls and the rock beneath the base (E_s and E_b).
2. The average unconfined compressive strength of the rock adjacent to the sidewalls and beneath the base (q_{us} , q_{ub})
3. The average roughness of the socket sidewalls.

Assessment of Items 1 and 2 are a basic part of rock mechanics and there are good guides in many texts for measuring and assessing these parameters.

The publication by Rowe and Armitage (Ref 12) is an excellent source of information.

There is no universal classification of roughness. A simple classification system for socket sidewalls, given by Pells, Rowe and Turner (Ref 10), is reproduced in Table 1. It has been found that sockets in sandstone need to be R2, or rougher, to preclude brittle failure of the interface. Sockets of R4 roughness may, in principle, be designed for higher side shear stresses than those of R2 or R3.

Table 1. Roughness Classification

ROUGHNESS CLASS	DESCRIPTION
R1	Straight, smooth sided socket, grooves or indentations less than 1.00mm deep
R2	Grooves of depth 1-4mm, width greater than 2mm, at spacing 50mm to 200mm
R3	Grooves of depth 4-10mm, width greater than 5mm, at spacing 50mm to 200mm
R4	Grooves or undulations of depth > 10mm, width > 10mm at spacing 50mm to 200mm

Substantial work on the fundamental influence of roughness on socket behaviour has been done at Monash University in the past decade. Seidel and Haberfield (Refs 13 and 14) have developed a roughness model based on the mean asperity angle and the scale (chord length) at which the mean angle is measured. Their research has shown that, at a given displacement, the shear resistance is controlled by the angles of asperities with chord lengths of twice this displacement. Thus if one wishes to compute the likely shear resistance at a displacement of 10mm the key parameter is the average angle of asperities with a chord length of about 20mm.

3.3 Applied Mechanics of Socket Behaviour

There are three very important matters of which engineers need to be aware when designing sockets.

The first is that load will be shared between the sidewall and base according to the relative stiffnesses of pile, sidewall rock and toe rock. It is simply not tenable to arbitrarily ascribe certain portions of load carrying capacity to the sidewalls and the base in accordance with notional allowable values. In other words allowable side shear and

allowable end bearing stresses are not additive. For example in a 5m long, 0.6m diameter socket in good quality sandstone it is probable that > 95% of the load will be taken by side shear.

The second is that provided sidewall roughness is R2 or better (see Table 1) the sidewall stress-displacement behaviour will be non-brittle. Peak shear strength will be mobilised at a small displacement and will then "hang in there" (ie plastic behaviour).

The third point is that peak side-shear resistance is usually mobilised at much smaller displacements than peak end bearing pressures.

These three points mean that in order to mobilise significant base resistance it is necessary to invoke sidewall slip. In other words one has to mobilise full sidewall resistance if one is to make use of the substantial capacity which may be available in end bearing. In turn this means that all the safety margin will be in end bearing.

If there is uncertainty as to the ultimate capacity in end bearing then mobilization of full side slip is not appropriate.

In regard to sidewall slip it should be noted that the progression from first slip, at the location of highest shear stress, to complete slip, takes place over a small interval of displacement (Refs 7 and 12). Therefore for most practical purposes it is appropriate to ignore the small region of load displacement behaviour representing progressive slip and to assume the relationship to be bilinear (see Figure 1).

4. DESIGN PARAMETERS

4.1 Sidewall Shear Resistance

Two paths have been taken in regard to the development of sidewall shear strength parameters.

By far the most commonly used approach is the development of empirical relationships between sidewall shear strength ($\tau_{ave peak}$) and the rock substance unconfined compressive strength (q_u), see Williams & Pells (Ref 18), Horvath (Ref 6) and Rowe & Armitage (Ref 12). The relationship is simply:

$$\tau_{ave peak} = \alpha q_u \dots\dots\dots(1)$$

Figure 2 gives the results of field and laboratory tests on mudstones and sandstones as evaluated by Williams & Pells (Ref 18). These data were included in a comprehensive review by Rowe &

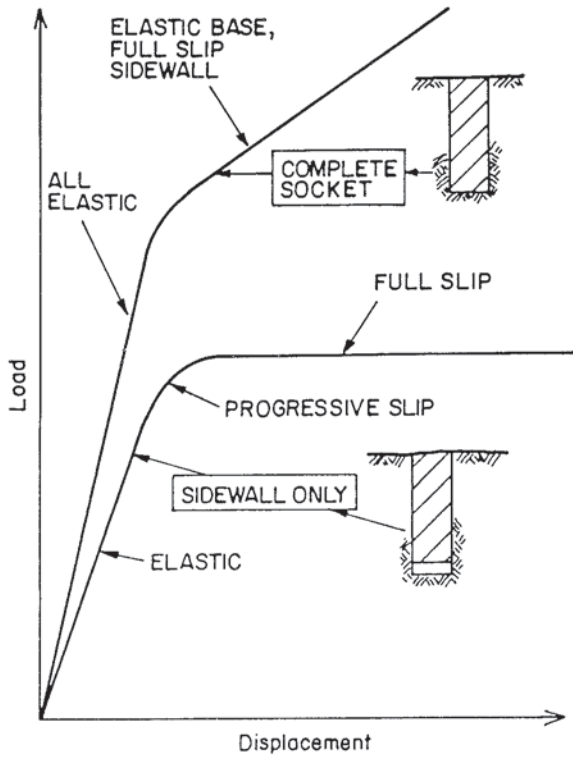

Figure 1: Simplified Load - Displacement Curves

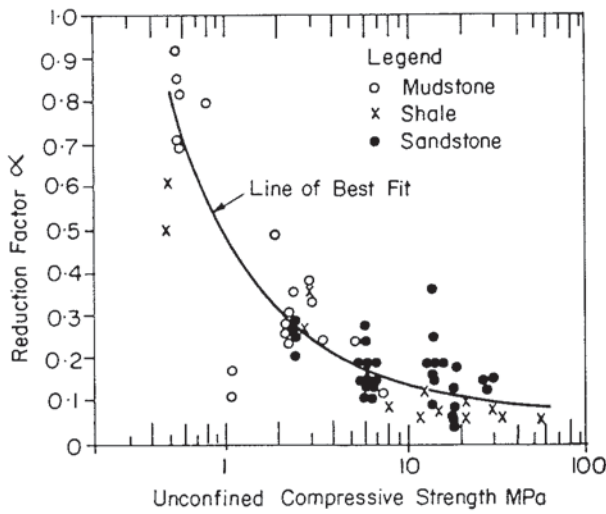

Figure 2: Side Shear Reduction Factor (Williams & Pells, Ref 18)

Armitage (Ref 12) and they proposed two relationships for α , namely:

Sockets of roughness R_3:

$$\tau_{ave\ peak} = 0.45\sqrt{q_u} \text{ (MPa)} \dots\dots\dots(3)$$

Sockets of roughness R_4

$$\tau_{ave\ peak} = 0.6\sqrt{q_u} \text{ (MPa)} \dots\dots\dots(4)$$

It should be noted that the above equations do not represent lower bounds to all data points but are close to the best fit equations and represent correlation coefficients of greater than 80%.

One of the problems with putting test data from all over the world in one basket is that there is a large scatter; geological differences and differences in construction methodology are lost. For example Figure 3 shows the relationship between $\tau_{ave\ peak}$ and q_u for sockets in the Hawkesbury Sandstone of the Sydney region. It can be seen that for sockets of roughness R_2 or better, $\alpha \geq 0.2$. This means that for typical fresh sandstone with q_u (saturated) of 20 MPa the peak side shear resistance is ≈ 4000 kPa. Equation 3 gives a value of 2000 kPa and Equation 4 gives 2700 kPa. Therefore, the writer strongly recommends that, when available, site or geology specific data be used for assessing

$\tau_{ave\ peak}$

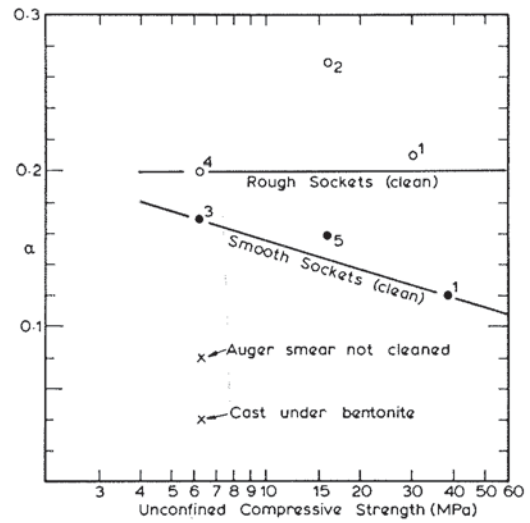

Figure 3: Side Shear Reduction Factor for Hawkesbury Sandstone

Williams & Pells (Ref 18) noted that the stiffness of the surrounding rock mass affects the side shear resistance and proposed a modification to Equation 1 to include a reduction factor for the influence of rock mass stiffness. Hence:

$$\tau_{ave\ peak} = \alpha\beta q_u \dots\dots\dots(5)$$

where

β = modulus reduction factor which can be estimated from Figure 4.

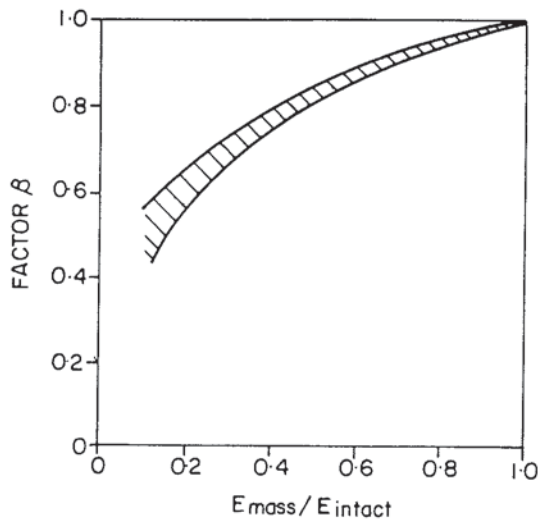

Figure 4: Reduction Factor for Rock Mass Stiffness

The second path which is being taken comes out of work at Monash University, Melbourne. Seidel and Haberfield (Refs 13 and 14) consider that sidewall shear stress versus displacement behaviour should be computed from fundamental parameters, these being:

1. Initial normal stress.
2. Intact rock strength (expressed as cohesion, c' , and friction, ϕ' , of the rock substance at the appropriate stress level).
3. Residual friction angle of the rock.
4. Diameter of the pile (which influences the effective boundary normal stiffness).
5. Rock mass modulus and Poisson's ratio (also influence the normal stiffness).
6. Socket roughness (including effects of smear and drilling fluid).

They point out that of these six factors (which involve 8 parameters), the initial normal stress and the rock mass Poisson's ratio play a minor role. They argue that working with fundamental parameters allows due cognisance to be taken of factors controlling sidewall behaviour, avoids ambiguities in the grey area between weak rock and strong soil (Ref 13), removes uncertainties in the empirical correlations (Equations 1 to 4) and should result in cheaper designs.

As pointed out by Seidel and Haberfield (Ref 13) their analytical model, which incorporates the six factors listed above, is of such complexity that manual solution is precluded and use has to be made of their program ROCKET. It is at this point that the writer feels some disquiet. Firstly one has to have a sound knowledge of the 8 input parameters. Secondly it is necessary for the

designer to have a good feel for the relative importance of the parameters.

To assess these matters the writer has used ROCKET to predict load-displacement curves for three of the side shear only tests conducted in Hawkesbury sandstone for the work reported in Reference 10. The details of the test sockets are given in Table 2. The first time predicted and measured side shear stress versus displacement curves are given in Figures 5, 6 and 7. The predictions range from being very good to poor.

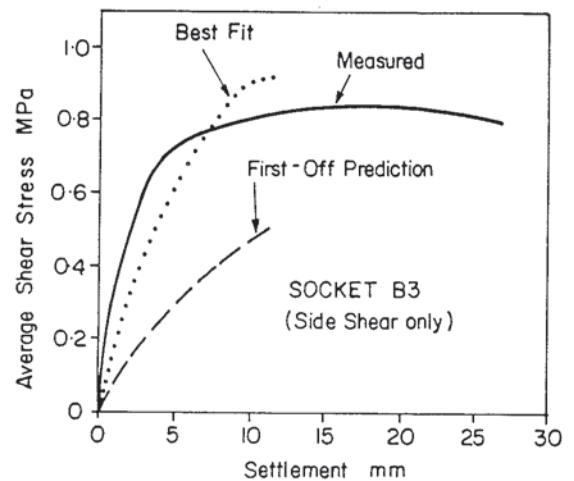

Figure 5: Comparison of measurement and ROCKET predictions, Socket B3, 0.32m diameter

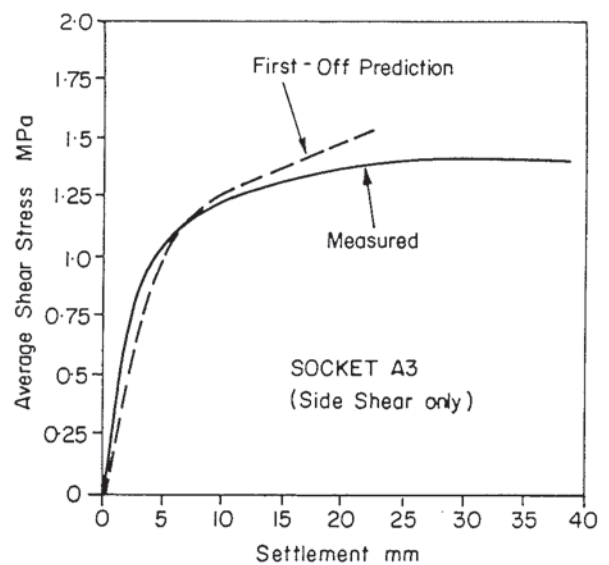

Figure 6: Comparison of measurement and ROCKET prediction, Socket A3, 0.32m diameter

Table 2
Parameters in Predictions Using ROCKET

PARAMETER	TEST SOCKET					
	A3		B3		D2	
	FIRST-OFF	BEST FIT	FIRST-OFF	BEST FIT	FIRST-OFF	BEST FIT
E_r (MPa)	360	360	350	900	400	1300
ν_r	0.2	0.2	0.2	0.2	0.2	0.2
c_i (kPa)	1300	1300	1300	1300	1300	1300
ϕ_i	42°	42°	42°	45°	42°	40°
ϕ_r	32°	32°	32°	32°	32°	32°
Segment Length - mix	25	25	25	25	75	30
Segment Height -mm	4.5	4.5	1.5	1.35	6.0	1.6
Length-m	0.4	0.4	0.52	0.52	0.9	0.9
Diameter-m	0.31	0.31	0.31	0.31	0.71	0.71

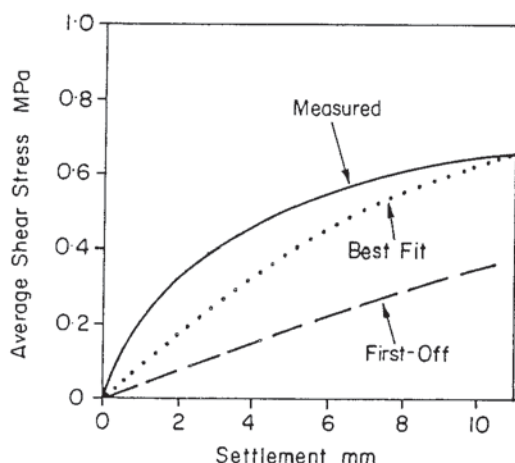

Figure 7: Comparison of measurement and ROCKET predictions, Socket D2, 0.71m diameter

Seidel and Haberfield (Ref 14) suggest that roughness is a critical factor with which designers have most difficulty. However, the writer had good data in this regard, although it did take a while to come to grips with the fact that to obtain an accurate computation of the shear strength mobilised at a particular displacement one has to use the asperity height for a chord length of twice the displacement. In further exploring the predictions given in Figures 5 to 7 it transpired that the computed shear stress-displacement curves were sensitive to the rock mass modulus. The combination of parameters which gave the best predictions were in some cases significantly different from those the writer first adopted based

on quite substantial knowledge of the Hawkesbury Sandstone and actual measured roughnesses. Of particular concern is that very different Young modulus values had to be used even though all three sockets were in the same rock mass. The parameters used for the first pass predictions are compared with the 'best fit' parameters in Table 3.

It is clear from the Users Manual for ROCKET, and the relevant papers (eg Refs 13 and 14), that the program has been primarily calibrated for Melbourne Mudstone. Seeing as the writer had mixed success with the program in predicting socket side shear behaviour in Hawkesbury Sandstone, a material whose engineering properties are reasonably well quantified, it would seem that significant development work is required before designers will be confident of the appropriate 8 parameters to use for rocks other than those similar to the Melbourne mudstone. This is in no way intended to denigrate the value of the Seidel-Haberfield approach, it simply means that, in the writer's opinion, it is too soon to categorise the ROCKET approach as a geographically broad based State of Practice.

4.2 End Bearing

Detailed discussions of the bearing capacity of rock are given in References 2, 3, 8, 11 and 19. It has been shown that:

1. For intact rock the ultimate bearing capacity is many times greater than the unconfined compressive strength (UCS) of the rock (see Tables 3 and 4 for example of theoretical calculations and field measurements).

Table 3 Theoretical Bearing Capacity of Rock

Method	Bearing Capacity as Multiple of Unconfined Compression Strength	
	$\phi_p = 40^\circ$	$\phi_p = 45^\circ$
Ladanyi expanding sphere	11	13
Modified Bell (brittle)	9	12
Classical plasticity	34	56

Table 4. Measured Bearing Capacities - Model and Field Tests

Material	Test Type	Substance Unconfined Strength (UCS) MPa	Bearing Capacity as Multiple of UCS
Sandstone (1)	Laboratory	20-33	11 (average)
Sandstone (2)	Laboratory	103	> 10
Limestone	Laboratory	75	7 to 11
Class 2 Hawkesbury	Field	14	5.5
Class 4 Hawkesbury	Field	6	2 to 2.5
Melbourne Mudstone (Surface)	Field	3	6 (brittle failures)
Melbourne Mudstone (L/D > 3)	Field	2	> 12.5 (work hardening)

- The load-displacement behaviour for a massive (intact) rock is nearly linear up to bearing pressures of between 2 and 4 times the UCS.
- The ultimate bearing capacity of a jointed rock mass beneath the toe of a socketed pile can be approximated by Ladanyi's spherical expansion theory which is:

$$q = \sigma_c \left[\frac{EN_\phi^{0.25}}{\sigma_c \left(N_\phi^{0.25} - \frac{1-\nu}{2\sqrt{2}} \right) \left(\frac{B}{S} + 3 \right)} \right]$$

where

$$\alpha = \frac{4 \sin \phi_r}{(1 + \sin \phi_r)}$$

- q = bearing pressure
- σ_c = unconfined compressive strength
- E = equivalent Young's Modulus
- B = diameter of the footing

- S = settlement
- $N_\phi = \tan^2 45 + \phi/2$
- ϕ_r = residual friction angle
- ν = Poissons Ratio

- Ultimate bearing capacities for intact and jointed rock are attained at large displacements, typically > 5% of the footing diameter (ie > 50mm for a 1m diameter pile).
- The load-deflection behaviour of a jointed rock mass is nearly linear up to pressures at which significant cracking propagates through inter-joint blocks. Based on the work of Bishnoi (Refs 2 and see Reference 7) such cracking may be expected at between about 75% and 125% of the UCS.

The above points mean that for socket design in many rock masses the base behaviour can be modelled as linearly elastic up to Serviceability Limits.

5. DESIGN SAFETY FACTORS - LIMIT STATE DESIGN

To date most design methods for rock sockets have been based on working loads coupled with conventional geotechnical engineering safety factors. Thus, for example, Williams & Pells (Ref 18) propose a working load Safety Factor of 2.5 for side shear only sockets.

Unfortunately geotechnical engineers are being dragged, kicking and screaming, into the structural engineer's world of Limit State Design. The current Australian Piling Code (AS2159-1995) is a Limit State document and therefore, reluctantly, the writer accepts that socket design must follow the same path. An interpretation of what this means is as follows.

5.1 Loads and Load Combinations

According to AS1170.1-1989 (Australian Loading Code) there are 6 basic combinations (plus 3 optional extras) of dead load, live load, wind load and earthquake load which have to be considered for assessment of the strength limit state. There are a further 5 different combinations for assuming short term serviceability limit states and a further 3 for long term serviceability limit states. In the writer's opinion this is a rather ridiculous state of affairs when it comes to foundation design but one with which we are stuck. In practice it is the writer's experience that the following combinations often govern designs of socketed piles.

Strength Limit State

Load (S*) = 1.25G + 1.5Q.....(6)

Load (S*) = 1.25G + W_u + ψ_cQ.....(7)

Long Term Serviceability

Load = G + ψ₁Q.....(8)

where

- G = dead load
- Q = live load
- W_u = wind load
- ψ_c = 0.4 (except for storage facilities where ψ_c = 0.6)
- ψ₁ = ψ_c

Earth pressure and liquid loads are considered as dead loads (part of G) for long term serviceability. For strength limit state, earth pressures are equivalent to live loads and liquid loads are equivalent to dead loads.

Note that in the jargon of Limit State design, the writer should have used the term 'Design Action Effect' rather than 'Load' in Equations 5 to 7. This obfuscation is unnecessary.

5.2 Strength and Serviceability

According to AS2159-1995 (Piling Code) the key definitions are:

Ultimate Strength

The limit state at which static equilibrium is lost or at which there is failure of the supporting ground or structural elements.

This covers four calculated values, namely:

- R_g* = Design geotechnical strength of pile
- R_{ug} = Ultimate geotechnical strength of pile
- R_s* = Design structural strength of pile
- R_{us} = Ultimate structural strength of pile

Serviceability

The limit state at which deformation of the piles will cause loss of serviceability of the structure.

(In ordinary English this means the pile loading which is constrained by allowable settlements, or

lateral movements. For some unknown reason this limit state is not given a sub and superscripted symbol).

5.2.1 Strength

The design geotechnical strength R_g* is simply a factored down version of the calculated ultimate geotechnical strength, ie:

$$R_g^* = \phi_g R_{ug}$$

The design requirement is R_g* > S*.

Various values of φ_g are given in Table 4.1 of AS2159 but none cover the methods used for calculating the ultimate capacity of rock sockets. In the writer's opinion the following values are appropriate for calculations of complete sockets (side shear and end bearing) using any of the methods given in Section 6 of this Paper.

- (i) Geological environments where there are substantial field testing data (in Australia this would at least include Melbourne mudstone and Hawkesbury sandstone) φ_g = 0.75
- (ii) Geological environments similar to (i) but where no specific field testing data are available φ_g = 0.65
- (iii) Geological environments not covered by the world wide data base on side shear and end bearing properties φ_g = 0.5

For side shear only sockets the recommended values for the categories listed above are:

- (i) φ_g = 0.6
- (ii) φ_g = 0.5
- (iii) φ_g = 0.35

The above recommendations presume that construction quality control of appropriate sidewall and base cleanliness is assured. If this is not the case then the Designer should be very conservative and it is not appropriate to give prescriptive design criteria.

Calculation of R_{ug} is discussed in Section 6.

5.2.2 Serviceability

Deflection limits (settlements and lateral movements) are constraints imposed by the structure and have to be provided by the Structural Engineer. In the absence of specific requirements it is usually reasonable to design for settlements, at pile head, of between 5mm and 15mm.

Interestingly AS2159 provides for no "safety factor" in design for serviceability. In fact Clause 4.4.4 states "calculations of settlement, differential settlement shall be carried out using geotechnical parameters which are appropriately selected and to which no reduction factor is applied". Apart from this clause being primarily a 'motherhood' statement, the writer considers that it is wrong. This is because, as is discussed in Section 6, socket design is often governed by serviceability. Yet no allowance is made for the substantial uncertainty in assessing ground deformation parameters.

It is recommended that modulus reduction factor should be applied for calculations relating to long term serviceability. Suggested values are:

- (a) Mean in situ deformation properties assessed from pressuremeter testing or other large scale in situ measurements $\phi_m = 0.75$
- (b) Mean in situ deformation properties assessed by correlation with rock mechanics indices such as RQD or RMR $\phi_m = 0.5$

6. DESIGN METHODS

As set out in Section 2, the writer considers that there are three design methods which may be used with confidence. These are summarised in the following sub-sections. Particular attention is given to Method 2 (Rowe and Armitage, Ref 12) because it is considered that this method allows the designer to fully appreciate the applied mechanics of the design process, the relative importance of geometric and geotechnical parameters and to produce an efficient, cost effective design.

6.1 Elastic Design

The elastic design method requires the use of the charts given in Figures 8 and 9. Figure 8 shows the proportion of load taken on the base (P_b) of the socket as a function of geometry and the ratio of socket stiffness to rock mass stiffness. Figure 9

gives the settlement influence factor for the equation:

$$\delta_v = \frac{P_t}{E_r D} I_s \dots\dots\dots(9)$$

- where
- δ_v = vertical settlements at top of socket
 - E_r = rock mass modulus
 - P_t = total load on pile
 - I_s = dimensionless settlement influence factor

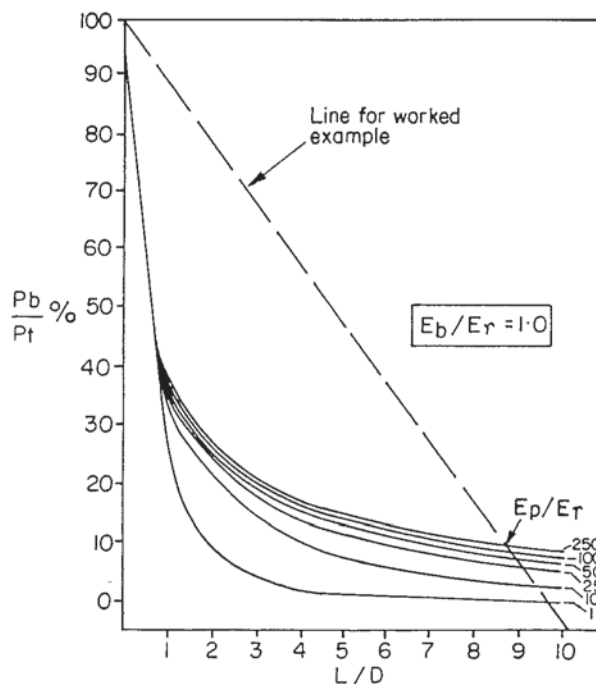

Figure 8: Elastic Load Distribution

Figures 8 and 9 are for a rock mass of uniform modulus. Similar charts are available for cases where the rock mass beneath the pile toe has a different modulus to that around the pile shaft. Such solutions are included in the solutions for sidewall slip given in Section 6.2. Charts are also available for a socket recessed below the rock surface (Ref 12).

The elastic procedure requires the designer to firstly assess:

- the strength limit state loads (S^*) as per equations 6 and 7 (or others in AS 1170.1)
- the long term serviceability load as per equation 8 (or others in AS 1170.1)
- serviceability settlement limit

- the ultimate side shear stress ($\tau_{ave\ peak}$) as per equation 5
- the end bearing stress up to which end bearing behaviour is effectively linearly elastic (q_{be})
- the ultimate end bearing stress (q_{built})
- the effective Young's modulus of the pile base (E_p) and of the surrounding rock (E_r)

The procedure is then as follows:

1. Select a pile diameter (D).
2. Using the strength limit state load (S^*) calculate the length of pile required if all the load were taken in side shear (L_{max}).
3. Calculate L_{max}/D and then draw a straight line on Figure 8 from $P_v/P_t = 100\%$ to the point L_{max}/D ; this straight line represents all pile lengths which satisfy $\tau_{ave\ peak}$. The dotted line on Figure 8 gives this solution for:

$$\begin{aligned} S^* &= 18000 \text{ kN} \\ \tau_{ave\ peak} &= 1000 \text{ kPa} \\ D &= 0.75\text{m.} \end{aligned}$$

4. The intersection of the straight line from Step 3 with the relevant curve of E_p/E_r gives a design solution. This step should use the assessed mean rock mass modulus. For the example shown in Figure 8 the design socket has $L/D = 9.2$ ie $L = 6.9\text{m}$, and only ~~1%~~ ^{3%} of the applied load would be taken on the base.

5. Figure 9 is then used to check the serviceability limit state by reading the settlement influence factor (I_δ) and calculating the predicted settlement using:

- mass modulus E_r multiplied by an appropriate reduction factor ϕ_m , and
- the long term serviceability load.

For the example

$$I_\delta = 0.27, E_r = 3500, \phi_m = 0.75$$

$$\delta_v = \frac{13000 \times 0.18}{3500 \times 0.75 \times 0.75} = 1.2\text{mm}$$

Handwritten notes: 0.37, 0.37, 2.4

Handwritten signature

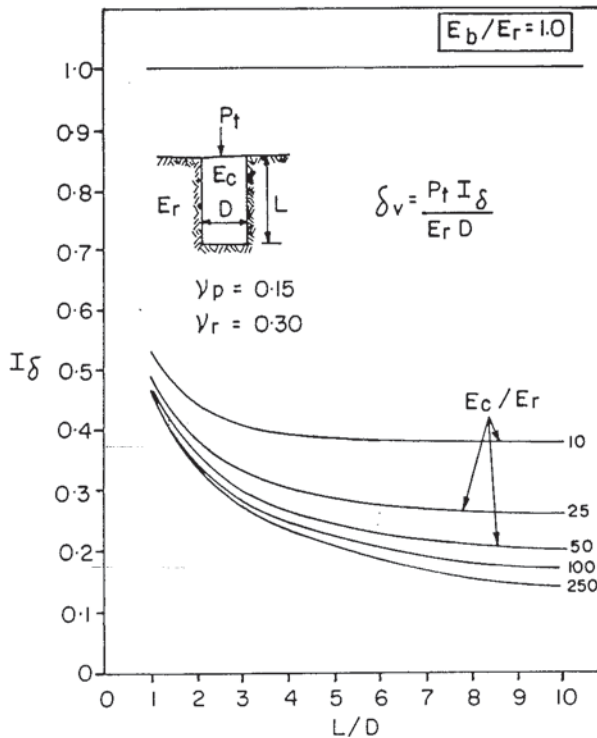

Figure 9: Elastic Settlement Influence Factors

6. Check that under serviceability the socket base load is less than the limit of linear elastic behaviour.
7. Calculate the ultimate geotechnical strength (R_{ug}) using the ultimate side shear and ultimate end bearing stresses. For the example presented here $q_{b\ ult} = 50 \text{ MPa}$, therefore $R_{ug} = 38 \text{ MN}$.
8. Check that $R_g^* = (\phi_g \times R_{ug})$ is greater than S^* . In the example, as in many cases, this is easily achieved.

The above process can be repeated for different diameters quite rapidly allowing selection of an appropriate socket diameter.

6.2 Design for Side Slip

Rowe and Armitage (Ref 12)

The substantial capacity which is typically available in end bearing cannot be mobilised unless sidewall slip is invoked. The method of Rowe and Armitage (Ref 12), which is the culmination of work first presented by Rowe and Pells (Ref 9), provides a chart-based method explicitly allowing for non-brittle sidewall slip.

The design procedure is quite similar to the elastic method described in Section 6.1. The procedure is described in some detail in Ref 12 and for ease of presentation here use is made of the same example presented for the elastic design method in Section 6.1.

Handwritten mark

The required parameters are the same as for the elastic design method. In the example these are:

- S^* = 18000 kN
- Serviceability load = 13000 kN
- Serviceability settlement = 8mm
- $\tau_{ave\ peak}$ = 1000 kPa
- q_{bc} = 15 MPa
- $q_{b\ ult}$ = 50 MPa
- E_p = 35000 MPa
- E_r = 3500 MPa

The Rowe and Armitage charts, all of which are reproduced at the end of this paper allow for differences between rock mass stiffness below the socket base and around the sidewall. For this example it is assumed that $E_b = E_r$.

The x and y axes of the charts are the same as the chart for elastic design. Therefore once one has selected the appropriate chart (in this case Figure A5) the same straight line can be drawn for a selected socket diameter (in this case 0.75m) as for the elastic procedure. This is shown as a dotted line in Figure A5. All points along this line satisfy the limit imposed by $\tau_{ave\ peak} = 1000$ kPa.

The next step is to determine the maximum base load at the limit of linearly elastic behaviour. In this case:

$$P_b = \frac{\pi \times 0.75^2}{4} \times 15000 = 6600 \text{ kN}$$

Therefore the maximum value of $P_b/P_t = 0.37$ (where $P_t =$ ultimate load, S^*). This provides a horizontal line on the Chart (see dashed line in Figure A5). The intersection of the two lines provides a design solution with $L/D = 6.3$ ($L = 4.7\text{m}$) and for which the settlement influence factor is about ~~0.32~~ **0.8**.

Therefore under serviceability load the predicted settlement is (from Equation 9).

$$\delta_v = \frac{13000}{3500 \times 0.75 \times 0.75} \times \frac{0.8}{0.32} \times 5.3 = 21\text{mm}$$

Checking for the ultimate geotechnical strength is the same as for the elastic method and is now:

$$R_{ug} = \pi \times 0.75 \times 4.7 \times 1.0 + \frac{\pi \times 0.75^2}{4} \times 50.0 = 33\text{MN}$$

$$R_{ug}^* = 0.65 \times 33 = 21\text{MN}$$



It can be seen that in the above example the design solution has been constrained by the linearity limit for end bearing and not by either the ultimate limit state or the serviceability limit state. The design could be pushed into the area of non-linear base response but the writer believes this to be unwise unless there are very good reasons to do so (eg like site specific test data and major economic benefits).

In the example the side slip design gave a socket length of 4.7m compared with 6.9m for the more conservative elastic design. This is a worthwhile saving for a trivial extra design effort.

Carter and Kulhawy (Ref 3)

The Rowe & Armitage method is based on the assumption of elasto-plastic side shear behaviour. The parameter $\tau_{ave\ peak}$ (equation 5) is taken as including effects of adhesion, friction and interface dilatancy. Slip initiates once this shear stress is attained at any point down the socket. In effect $\tau_{ave\ peak}$ is equivalent to a purely cohesive interface.

Field tests on side shear only sockets indicate that the purely cohesive (elasto-plastic) assumption is safe provided the sidewall roughness is R_2 or better (ie brittle shear-displacement behaviour does not occur). However, as discussed in Section 4.1, real sidewall behaviour is a complex function of interface stiffness, adhesion, friction and dilatancy.

Carter and Kulhawy (Ref 3) provided approximate (but accurate) generalised analytical equations for load-displacement behaviour of complete, and side shear only sockets, under axial compression and uplift for sideshear being a function of cohesion (c), friction (ϕ) and interface dilatancy (ψ). Their calculations cover elastic behaviour and full slip, the small region of progressive slip is not modelled.

The equations for a complete socket with c , ϕ and ψ parameters are quite complex but could be easily dealt with using a program such as MATHCAD. However, the writer is of the opinion that if a designer wishes to invoke fundamental side shear parameters he or she would be better off using the program ROCKET.

For the simplifying assumption of elasto-plastic behaviour, as made by Rowe and Armitage, the equations are as follows:

Elastic Phase

$$\delta_v = \frac{4P_t(1-\nu_r)}{E_r D} \left[\frac{4P_t(1-\nu_r) \left(\frac{4}{1-\nu_b} \right) \left(\frac{2L}{D\pi k_1} \right) \left(\frac{\tanh(\mu L)}{\mu L} \right)}{k_1 \left(\frac{4}{1-\nu_b} \right) + \frac{4\pi L \tanh(\mu L)}{k_2 D \mu L}} \right] \dots(10)$$

where

- δ_v = settlement at top of socket
- P_t = load on socket
- E_r = rock modulus around shaft
- ν_r = Poisson's ratio around shaft
- ν_b = Poisson's ratio of rock beneath base
- D = diameter of socket
- L = length of socket
- λ = $\frac{2E_c(1+\nu_r)}{E_r}$
- E_b = modulus of rock beneath base
- E_c = modulus of concrete shaft
- k_1 = G_r/G_b (ratio of shear moduli of sidewall and base rock) may be taken as $= E_r/E_b$.

$$k_2 = Ln \left[\frac{5L}{D} (1-\nu_r) \right]$$

$$\mu = \frac{2}{D} \sqrt{\frac{2}{k_1 \lambda}}$$

Full Slip Phase

$$\delta_v = \frac{L}{E_c} \left[\frac{4P_t}{\pi D^2} - \frac{2L \tau_{ave peak}}{D} \right] + \frac{\pi D(1-\nu_b^2)}{E_b} \left[\frac{P_t}{\pi D^2} - \frac{L \tau_{ave peak}}{D} \right] \dots(11)$$

Equations are also available for calculating the proportion of load reaching the base of the pile. These are:

Elastic Phase

$$\frac{P_b}{P_t} = \frac{k_2 D \mu L}{\cosh(\mu L) [k_2 D \mu L + k_1 (1-\nu_b) \pi L \tanh(\mu L)]} \dots(12)$$

Full Slip Phase

$$\frac{P_b}{P_t} = 1 - \frac{\pi D L \tau_{ave peak}}{P_t} \dots(13)$$

The above equations give good agreement with the Rowe & Armitage charts which were based on finite element analyses. The advantage of the

equations is that one does not have to have access to all the charts. They also allow consideration of properties outside the range covered by the charts. However, in the writer's opinion the major disadvantage is the loss of the simple graphical analysis procedure outlined above which allows the designer to readily appreciate the relative influence of geometrical and geotechnical parameters on the design.

The application of the Carter & Kulhawy equations to a design example is presented in Section 6.3. However, before leaving, it is worth drawing the readers attention to the fact that equation 13 is the same equation as used for drawing the straight line on the design charts for the elastic and Rowe & Armitage design methods.

6.3 Non-Linear Analysis

Following extensive field testing as part of Adrian Williams' doctoral thesis, workers at Monash University developed an empirical design method which included the non-linear behaviour of a complete rock socket (Ref 17). The method could, in principle, be used for any geological environment but required good field test data to provide the empirical parameters. It became quite widely used in Melbourne mudstone, and in some other areas. The method was a little laborious and it is understood (Seidel, personal communications) that the advent of the computer program ROCKET has largely lead to the demise of the Williams' method.

As already discussed in Section 4.1, ROCKET models non-linear sidewall shear behaviour. This is coupled with an assumption of linear load-displacement behaviour of the base in order to predict load displacement behaviour of a complete socket.

As set out in Ref 14 (Part 3) ROCKET essentially addresses vertical slip displacements between concrete shaft and rock. To calculate total displacements of a complete socket additional calculations are made of:

- vertical elastic deformation of the rock mass, and
- elastic shortening of the shaft.

The writer, as with all other users, has no knowledge of the inner workings of ROCKET. It is a reasonably user-friendly program which clearly, in principle, allows a designer to explore the sensitivity of a design to the 8 input parameters which affect sidewall behaviour. However, a proper parametric study of 8 parameters is not a trivial undertaking. In this regard the full explicit

equations of Carter and Kulhawy (Ref 3) for sidewall behaviour as a function of c , ϕ and ψ are attractive. With MATHCAD, or similar software, a user can vary rapidly conduct a complete sensitivity analysis.

As an assessment of ROCKET, and the other design methods discussed in Section 6.1 and 6.2 the writer has reviewed the design of a recently completed socket for a 22500 KN working load column in the Sydney CBD. The geotechnical model for the socket is given in Figure 10. A 1.3m diameter socket was adopted for structural reasons and was constructed with a length of 2.4m.

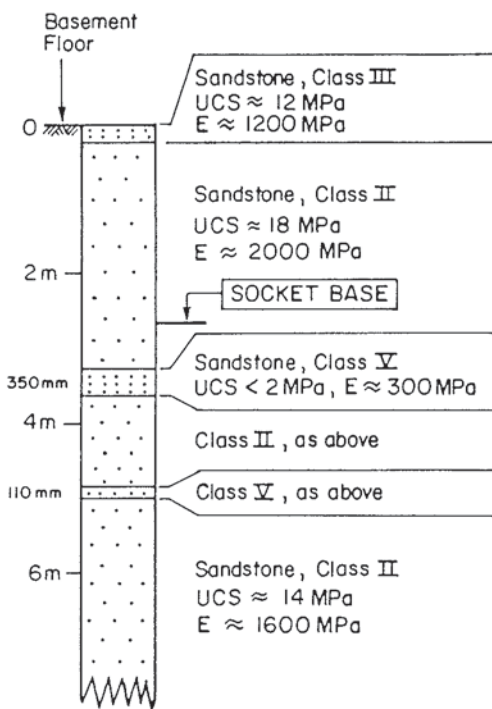

Figure 10: Profile for Sydney CBD Building

The socket was originally designed for side slip using the Rowe and Armitage method. The elastic method would have required a socket length of 4.8m (ie double the actual design). For the purposes of this paper settlements were calculated using the different methods outlined above, with the following results:

Rowe and Armitage	6 mm
Carter and Kulhawy	6mm
ROCKET	8mm to 10mm, depending on roughness characterisation

From the practical viewpoint the above answers are essentially the same.

The computed ultimate capacity using the hand method is ≈ 120 MN. It was found to be difficult to compute the ultimate capacity using ROCKET because the program truncates computations at a displacement of half the chord length specified for roughness. The asperity height can be factored by $\sqrt{2}$ or $\sqrt{3}$ for doubling and quadrupling the chord lengths but the program does not accept chord lengths $> 10\%$ of the socket diameter. However, using the computed side shear stresses the ultimate capacity was estimated as > 130 MN.

This example showed that in analysing an existing socketed pile the different methods, which incorporate side slip, gave similar results. However, the writer has found that for design work the chart based system of Rowe and Armitage is quicker and gives a better "feel" for the problem than the numerical methods.

7. DESIGN FOR LATERAL LOADS

Design methods for lateral loading are not nearly as well researched and established as for axial compression and tension. Solutions developed for laterally loaded piles in soil do not cover relatively short sockets in stiff rock.

Carter and Kulhawy (Ref 3) present finite element and approximate closed form elastic solutions for lateral movements and pile head rotations. Two situations are considered as shown in Figure 11. The closed form solutions for no overlying soil are as follows.

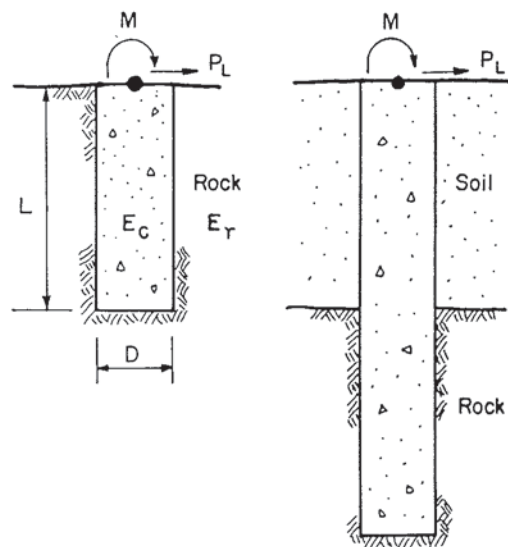

Figure 11: Geometric Conditions for Elastic Solutions by Carter and Kulhawy (Ref 3)

Flexible Pile

$$\delta_e = \frac{P_L}{2G^*D} \left(\frac{E_e}{G^*}\right)^{-0.143} + \frac{1.08M}{G^*D^2} \left(\frac{E_e}{G^*}\right)^{-0.429} \dots(14)$$

$$\theta = \frac{1.08P_L}{G^*D^2} \left(\frac{E_e}{G^*}\right)^{-0.429} + \frac{6.4M}{G^*D^2} \left(\frac{E_e}{G^*}\right)^{-0.714} \dots(15)$$

Rigid Piles

$$\delta_e = \frac{0.4P_L}{G^*B} \left(\frac{2L}{D}\right)^{-0.333} + \frac{0.3M}{G^*D^2} \left(\frac{2L}{D}\right)^{-0.875} \dots(16)$$

$$\theta = \frac{0.3P_L}{G^*D^2} \left(\frac{2L}{D}\right)^{-0.875} + \frac{0.8M}{G^*D^3} \left(\frac{2L}{D}\right)^{-1.667} \dots(17)$$

where:

- P_L = lateral load
- M = moment at head of pile
- L = length
- D = diameter
- G^* = $G_r (1+0.75v_r)$
- G_r = shear modulus of rock mass
= $E_r/2(1+v_r)$
- E_e = $\frac{64(EI)_c}{\pi D^4}$
- $(EI)_c$ = bonding rigidity of shaft

The conditions for which equations 14 to 17 are valid are shown in Figure 12. For intermediate stiffness shafts Carter and Kulhawy show, from finite element analyses, that displacements may be taken as 1.25 times the maximum of:

- the values from equations 14 and 15 with E_e/G^* as for the actual shaft, or
- the values from equation 16 and 17 with L/D as for the actual shaft.

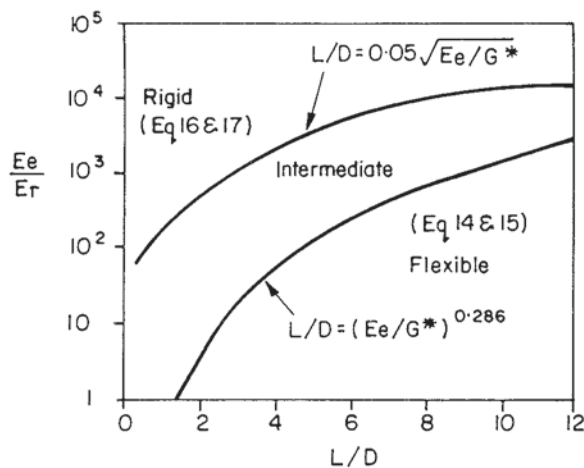

Figure 12: Criteria for Equation Selection

For the second situation shown in Figure 11 an assumption is made about the distribution of soil reactions on the shaft. The problem is then decomposed into two parts with the shaft in the soil analysed as a determinant beam with known loading. The horizontal forces and moments at rock head can then be calculated. Equations 14 to 17 can then be invoked.

As an alternative to the above approach Wyllie (Ref 19) recommends using computer programs based on the p-y method. The limitations of this method are discussed by Carter & Kulhawy (Ref 3).

The only project on which the writer has worked which has required serious consideration of lateral loading was the Sydney Monorail. This was analysed using linearly elastic finite element methods which are effectively encapsulated in the equations of Carter and Kulhawy.

8. CONCLUSIONS

1. The design parameters for rock socketed piles depend substantially on construction techniques and quality, particularly in regard to sidewall cleanliness and roughness, and base cleanliness.
2. Well established design methods exist for rock sockets loaded axially in compression but these methods can only be applied with confidence where sockets are constructed with appropriate roughness and cleanliness.
3. Sockets should be designed using a Limit State approach.
4. The substantial capacity normally available in base resistance can usually only be mobilised by invoking sidewall slip but sidewall roughness of R_2 or better should be available to ensure non-brittle sidewall behaviour.
5. The elastic design method is conservative and should be adopted if sidewall slip is not to be mobilised.
6. The method of Rowe & Armitage (Ref 12) is recommended for design of sockets with sidewall slip.
7. Fundamental parameters controlling side shear behaviour may be used in design via programs such as ROCKET provided the designer has good knowledge of the

parameters and the sensitivity of the design to uncertainties in these parameters.

8. Additional research work is required to provide design guidelines in relation to lateral loads on rock sockets. Elastic displacements and rotations can be calculated using equations developed by Carter and Kulhawy but at this time there is little basis for rational assessment of ultimate capacity.

9. REFERENCES

1. American Society of Civil Engineers (1996). Rock Foundations. Technical Engineering and Design Guides As Adapted from US. Corps of Engineers No 16, ASCE Press, New York.
2. Bishnoi, B.L. (1968). Bearing Capacity of Closely Jointed Rock. PhD Thesis Georgia Institute of Technology, Atlanta.
3. Carter, J.P. and Kulhawy, F.H. (1987). Analysis and Design of Drilled Shaft Foundations Socketed into Rock. Report 1493-4 for Electric Power Research Institute, Palo Alto, California.
4. Gill, S.A. (1970). Load Transfer Mechanism for Caissons Socketed into Rock. PhD Thesis, Northwestern University.
5. Holden, J.C. (1984) Construction of Bored Piles in Weathered Rocks. Road Construction Authority of Victoria, Technical Report No 69.
6. Horvath, R.G. (1982). Behaviour of Rock-Socketed Drilled Pier Foundations. PhD Thesis, University of Toronto.
7. Kulhawy, F and Carter, J.P. (1988). Design of Drilled Shaft Foundations. Univ. Sydney, Short Course Lecture Notes, Sydney.
8. Ladanyi, B. and Roy, A. (1972). Some Aspects of Bearing Capacity of Rock Masses. Proc. 7th Canadian Symposium on Rock Mechanics, Edmonton.
9. Rowe, R.K. and Pells, P.J.N. (1980). A theoretical study of pile-rock socket behaviour. Int. Conf. Structural Foundations on Rock, Sydney, Balkema.
10. Pells, P.J.N., Rowe, R.K. and Turner, R.M. (1980). An Experimental Investigation into Side Shear for Socketed Piles in Sandstone. Int. Conf. Structural Foundations on Rock, Sydney, Balkema.
11. Pells, P.J.N. and Turner, R.M. (1980) End bearing on Rock with Particular Reference to Sandstone. Int. Conf. Structural Foundations on Rock, Sydney, Balkema.
12. Rowe, R.K. and Armitage, H.H. (1984). The Design of Piles Socketed Into Weak Rock, Geotechnical Research Report GEDT-11-84, University of Western Ontario.
13. Seidel, J.P. and Haberfield, C.M. (1995). The Axial Capacity of Pile Sockets in Rocks and Hard Soils. Ground Engineering, March 1995.
14. Seidel, J. and Haberfield, C.M. (in Press). The Shear Behaviour of Concrete - Soft Rock Joints. Part 1: Experimental Investigations; Part 2: Theoretical Analysis; Part 3: Performance of Drilled Shafts. ASCE Journal of Geotechnical Engineering.
15. Webb, D.L. and Davies, P. (1980). Ultimate Tensile Loads of Bored Piles Socketed into Sandstone Rock. Inst. Conf of Structural Foundations on rock, Sydney, Balkema.
16. Williams, A.F. (1980). The Design and Performance of Piles Socketed into Weak Rock. PhD Thesis, Monash university.
17. Williams, A.F, Johnston, I.W. and Donald, I.B. (1980). The Design of Socketed Piles in Weak Rock. Int. Conf. Structural Foundations on Rock, Sydney Balkema.
18. Williams, A.F and Pells, P.J.N. (1981). Side Resistance Rock Sockets in Sandstone, Mudstone and Shale. Canadian Geotechnical Journal, Vol 18, p 502-513.
19. Wyllie, D.C. (1992). Foundations on Rock. Spon.

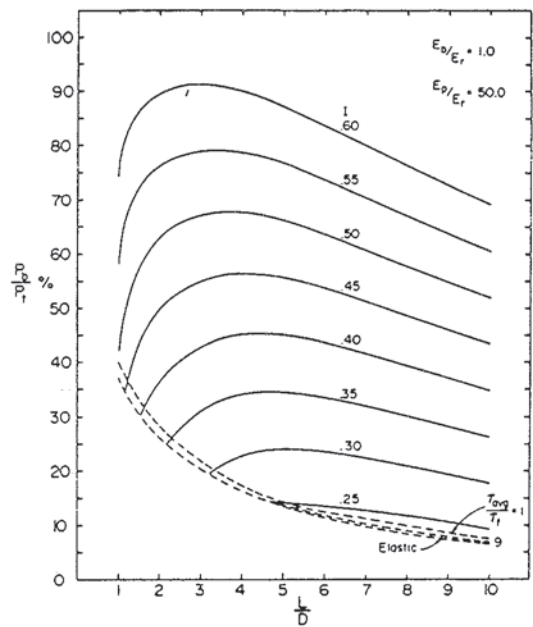
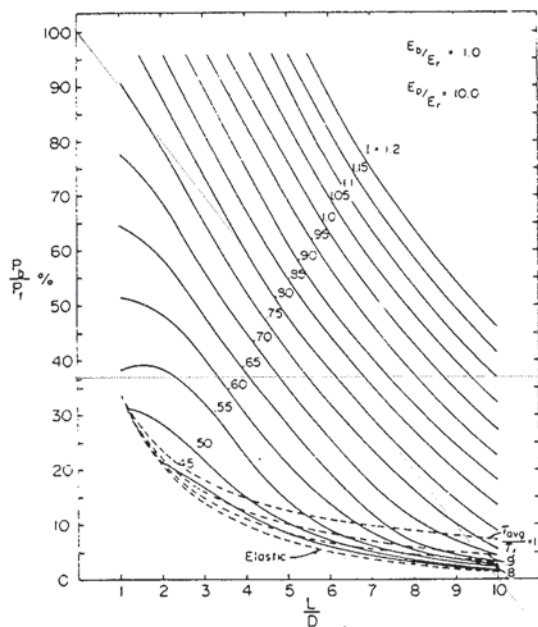
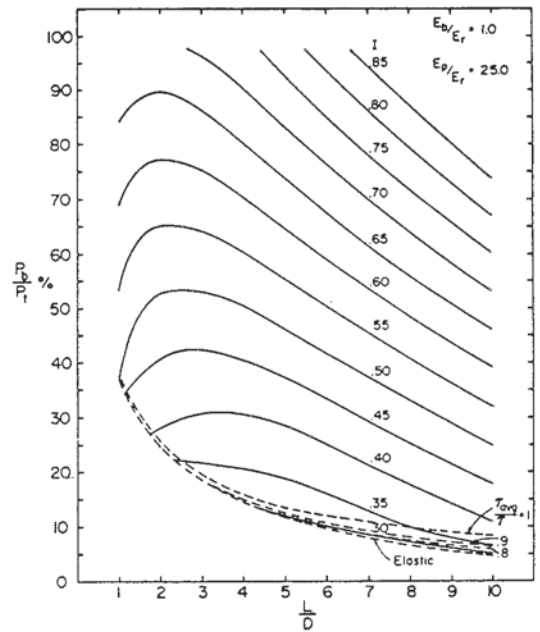
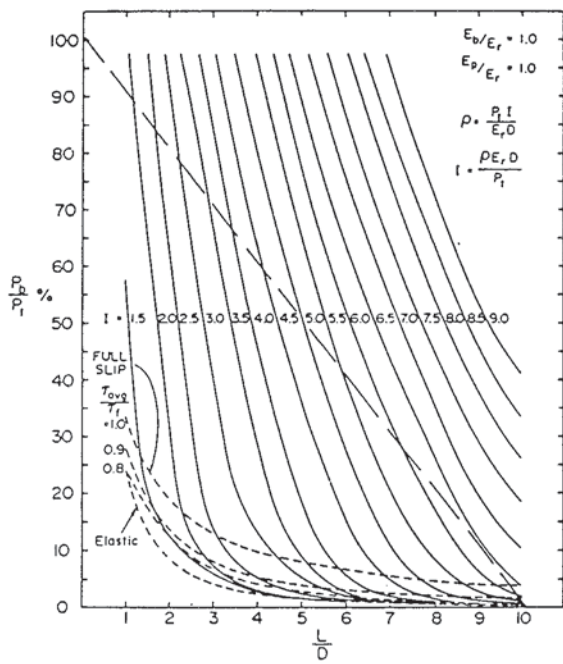

REPRODUCTION OF ROWE AND ARMITAGE CHARTS

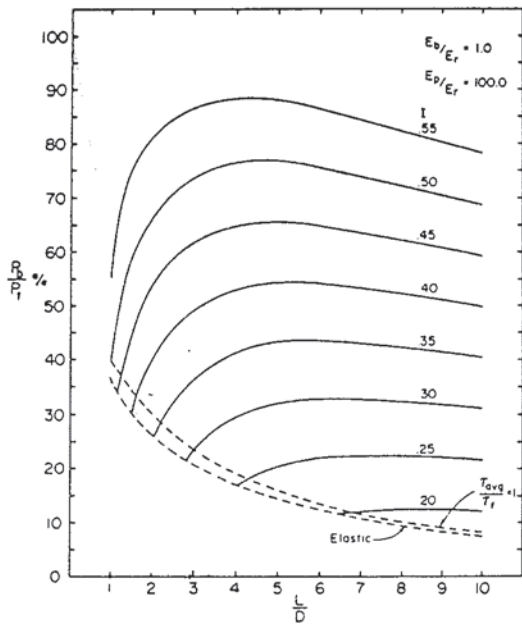

Figure A5 ($E_b/E_r = 1$)

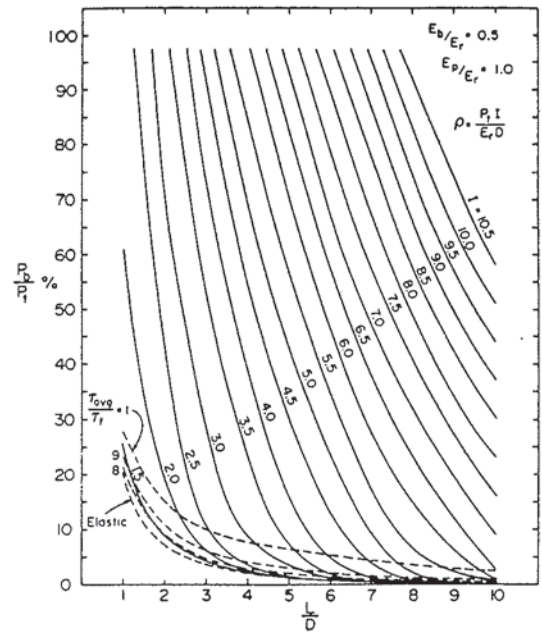

Figure A7 ($E_b/E_r = 0.5$)

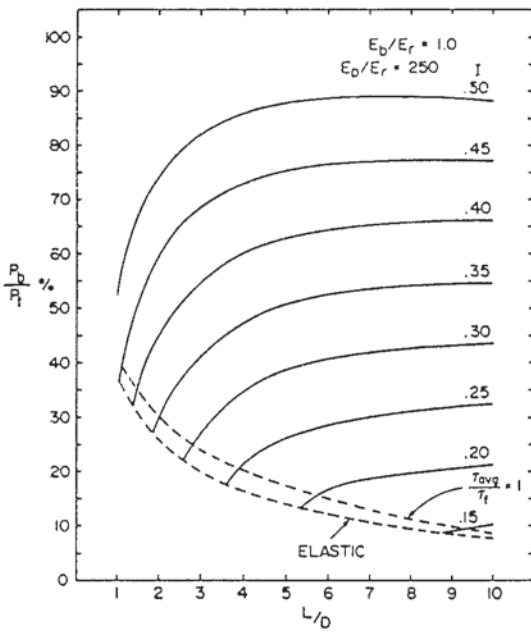

Figure A6 ($E_b/E_r = 1$)

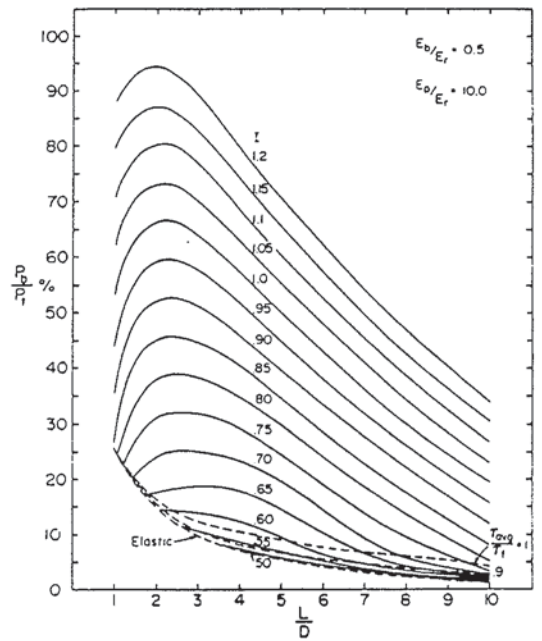

Figure A8 ($E_b/E_r = 0.5$)

REPRODUCTION OF ROWE AND ARMITAGE CHARTS

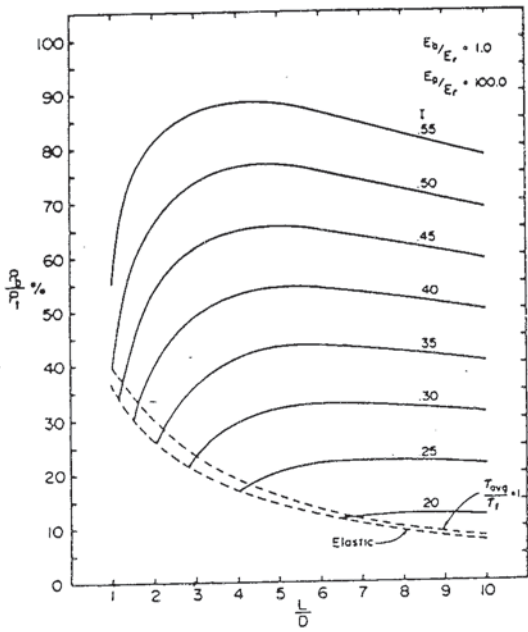

Figure A5 ($E_v/E_r = 1$)

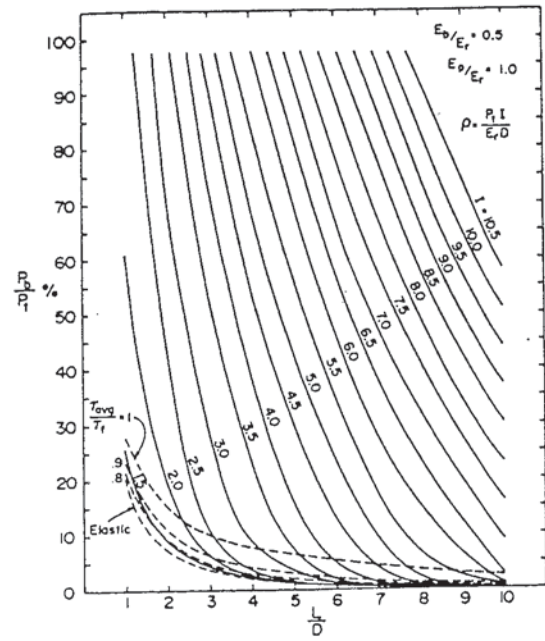

Figure A7 ($E_v/E_r = 0.5$)

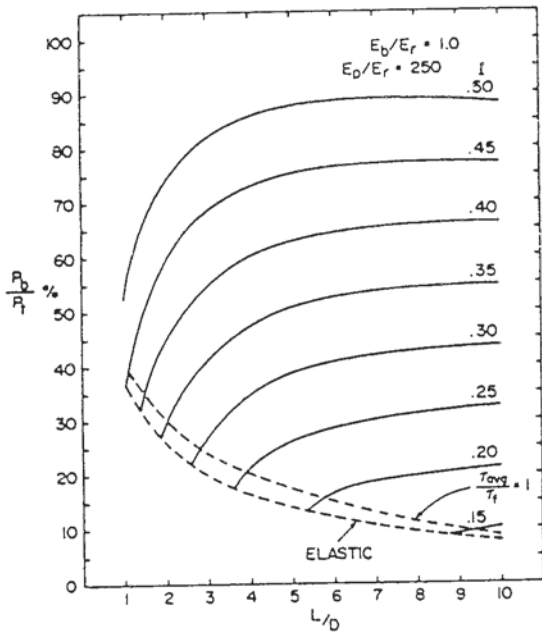

Figure A6 ($E_v/E_r = 1$)

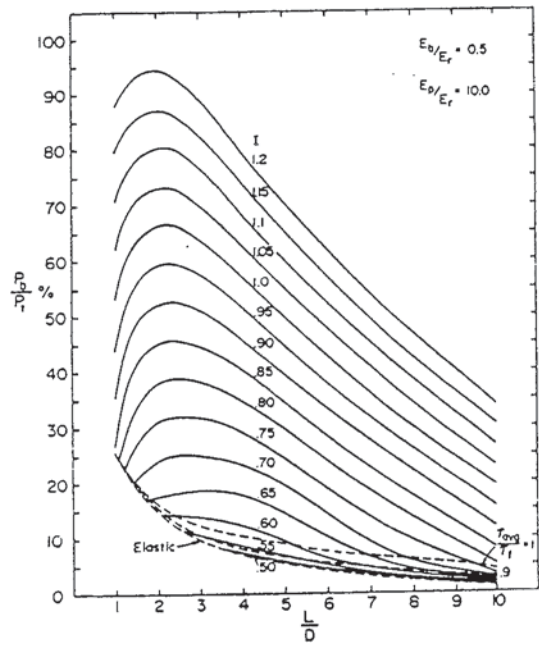

Figure A8 ($E_v/E_r = 0.5$)

REPRODUCTION OF ROWE AND ARMITAGE CHARTS

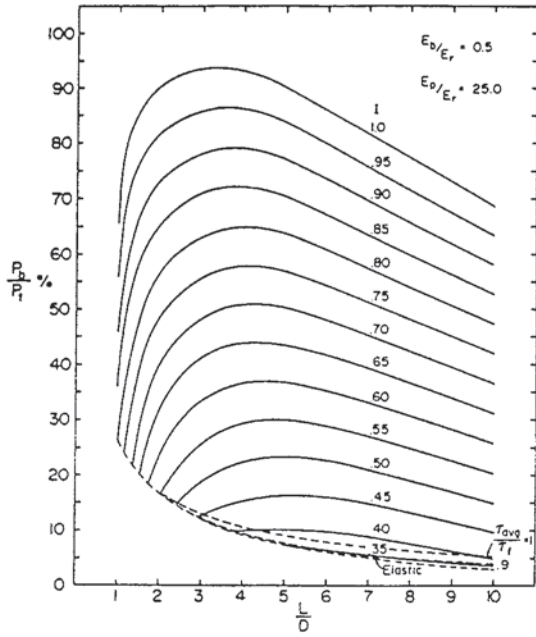

Figure A9 ($E_v/E_r = 0.5$)

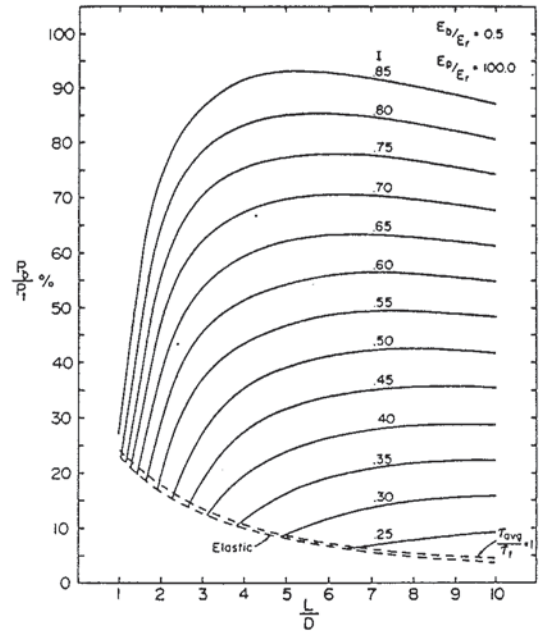

Figure A11 ($E_v/E_r = 0.5$)

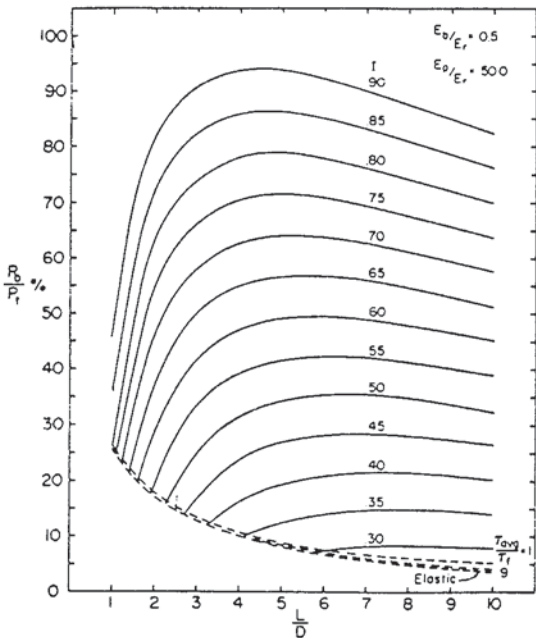

Figure A10 ($E_v/E_r = 0.5$)

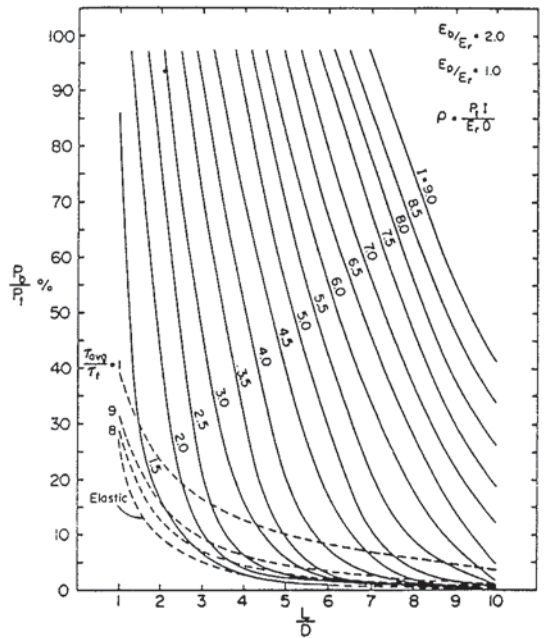

Figure A12 ($E_v/E_r = 2$)

REPRODUCTION OF ROWE AND ARMITAGE CHARTS

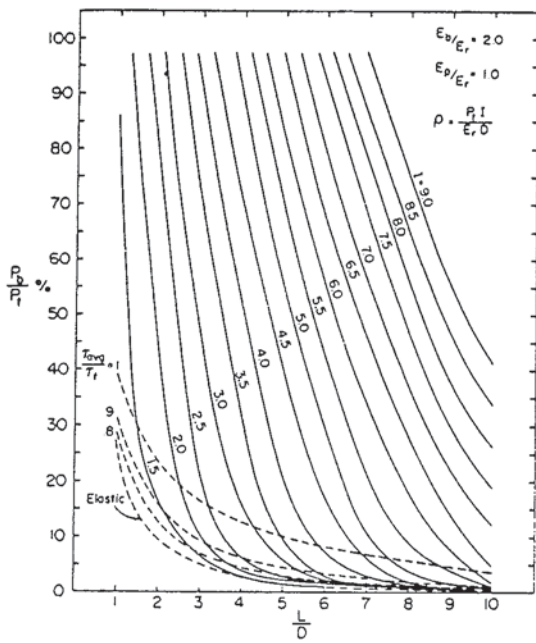

Figure A13 ($E_v/E_r = 2$)

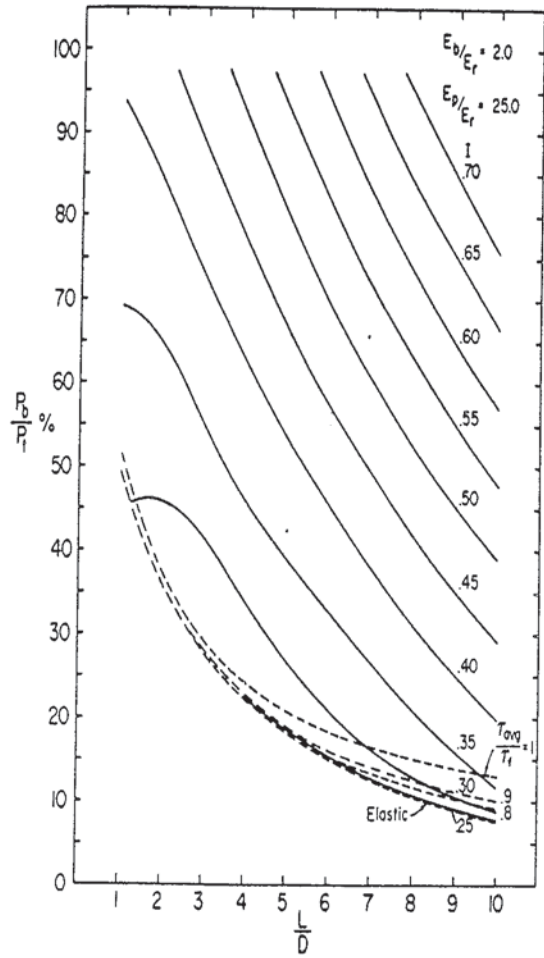

Figure A15 ($E_v/E_r = 2$)

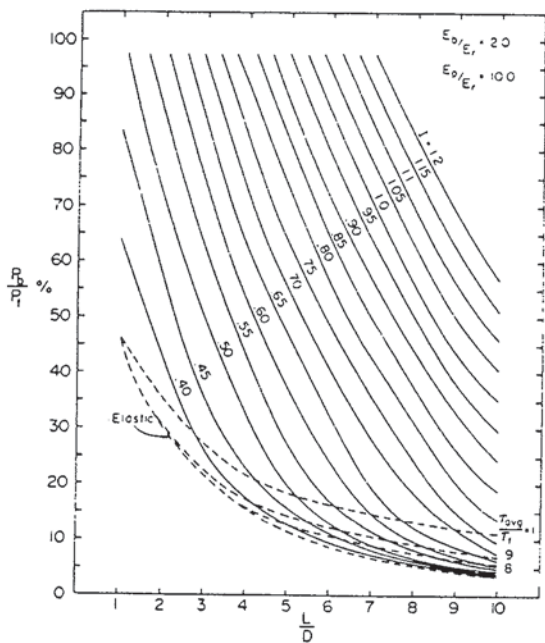

Figure A14 ($E_v/E_r = 2$)

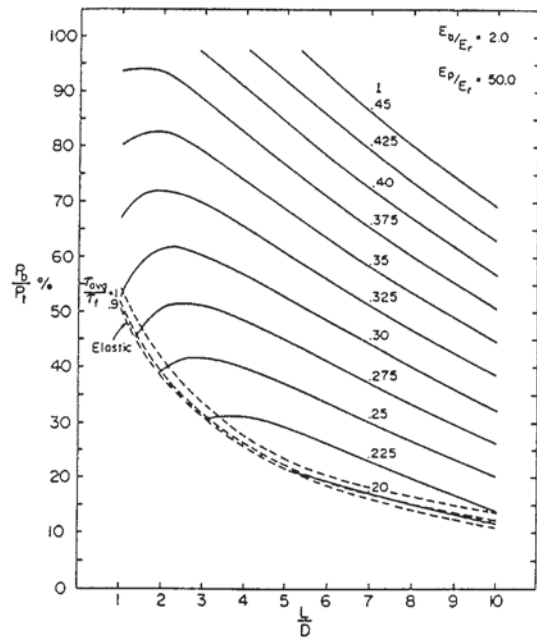

Figure A16 ($E_v/E_r = 2$)

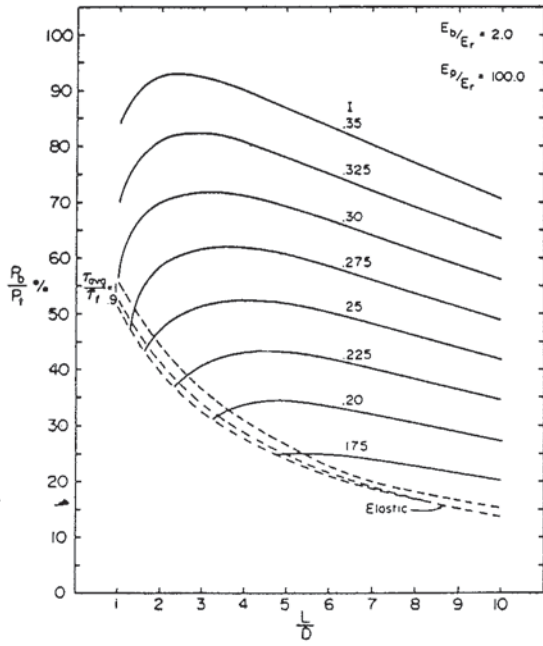

Figure A17 ($E_b/E_r = 2$)

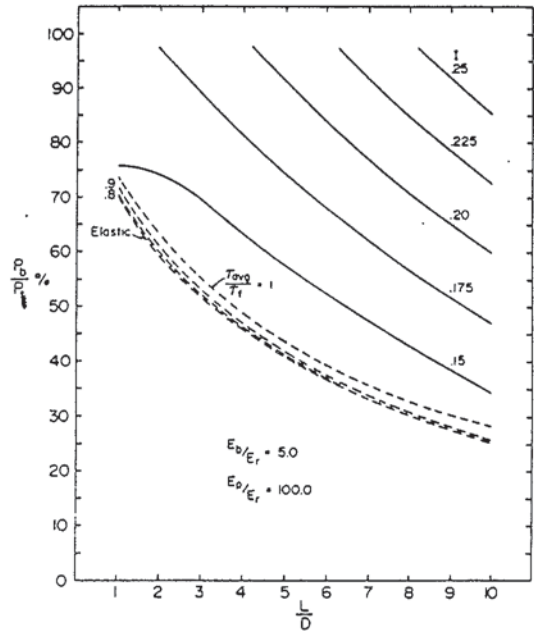

Figure A19 ($E_b/E_r = 5$)

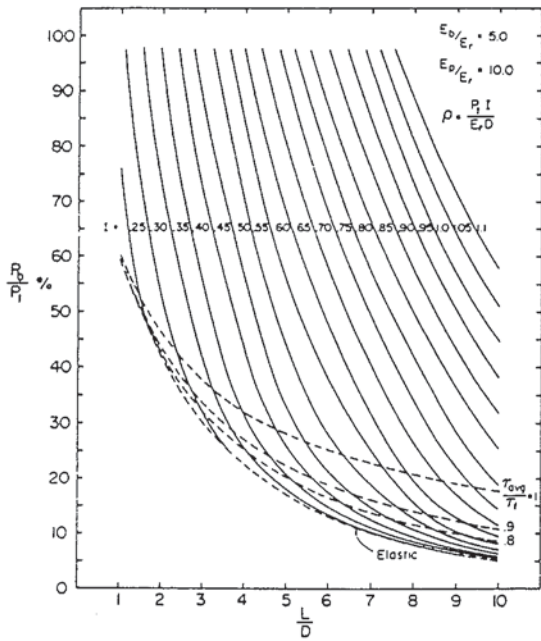

Figure A18 ($E_b/E_r = 5$)

REPRODUCTION OF ROWE AND ARMITAGE CHARTS